



# TOWN COUNCIL – AGENDA REQUEST FORM

THIS FORM WILL BECOME PART OF THE BACKGROUND INFORMATION USED BY THE COUNCIL AND PUBLIC

Please submit Agenda Request Form, **including back up information**, 8 days prior to the requested meeting date. **Public Hearing requests must be submitted 20 days prior to requested meeting date to meet publication deadlines** (exceptions may be authorized by the Town Manager, Chairman/Vice Chair).

## MEETING INFORMATION

Date Submitted: 6/14/23 Date of Meeting: 6/22/23  
 Submitted by: Kaytlynn Monroe, National Grid - Twin  
 States Clean Energy Link  
 Department: Time Required: 20-30mins - flexible  
 Speakers: Project team Background Info. Yes:  No:   
Supplied:

## CATEGORY OF BUSINESS (PLEASE PLACE AN "X" IN THE APPROPRIATE BOX)

Appointment:	<input checked="" type="checkbox"/>	Recognition/Resignation/Retirement:	<input type="checkbox"/>
<b>Public Hearing:</b>	<input type="checkbox"/>	Old Business:	<input type="checkbox"/>
New Business:	<input type="checkbox"/>	Consent Agenda:	<input type="checkbox"/>
Nonpublic:	<input type="checkbox"/>	Other:	<input checked="" type="checkbox"/>

## TITLE OF ITEM

Twin States Clean Energy Link

## DESCRIPTION OF ITEM

Twin States is a 1,200 megawatt clean energy transmission project which will be buried along state roads in Vermont and New Hampshire and utilizes the existing National Grid-owned and operated transmission corridor from Monroe to Londonderry.

## REFERENCE (IF KNOWN)

RSA:	Warrant Article:
Charter Article:	Town Meeting:
Other:	N/A

## EQUIPMENT REQUIRED (PLEASE PLACE AN "X" IN THE APPROPRIATE BOX)

Projector:	<input checked="" type="checkbox"/>	Grant Requirements:	<input type="checkbox"/>
Easel:	<input type="checkbox"/>	Joint Meeting:	<input type="checkbox"/>
Special Seating:	<input type="checkbox"/>	Other:	<input type="checkbox"/>
Laptop:	<input type="checkbox"/>	None:	<input type="checkbox"/>

## CONTACT INFORMATION

Name:	<u>Kaytlynn Monroe</u>	Address	<u>Concord, NH</u>
Phone Number	<u>603-219-8815</u>	Email Address	<u>kmonroe@hilltoppublicsolutions.com</u>

## APPROVAL



## Project Briefing – Merrimack, NH

# How New England generates power today, and in the future

YESTERDAY VS. TODAY

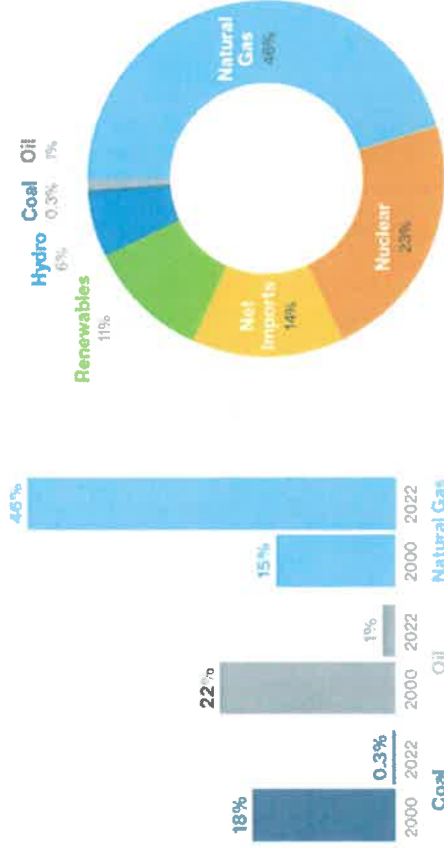

## Where does our power come from now?

- Even with retirements, New England’s power supply remains heavily reliant on fossil fuel generation, mostly natural gas, that emits a significant amount of greenhouse gases.

## Where will New England’s future power supply come from?

- The region’s state policymakers have set aggressive goals to make our power supply greener
- Meeting these goals requires the connection of lots of wind and solar generation over the coming decade—and importing a significant amount of Canadian clean energy.
- This transition will create thousands of new good paying local jobs
- In fact, the Energy Transition, as it is called, will be the largest transformation of how we produce our power in a lifetime

## Proposed Generation

Developers have proposed nearly 32,000 MW of new generating resources as of January 2023.

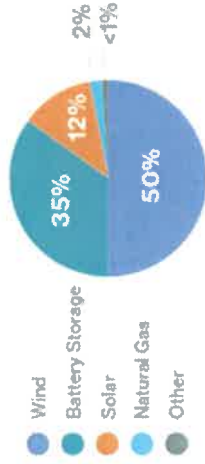

Source: ISO New England

## The obstacles to a clean energy future

### What are the challenges in achieving the Energy Transition?

- Wind and solar power output moves up and down depending on weather conditions, cloud cover, time of day, and other factors.
- To keep our grid reliable, we need a controllable backup source of power when clean power output is low, but customer demand is high.
- Experts agree that if the region doesn't take action, fossil fuel generation will be the primary source of backup power. This harms our ability to get to a greener future.

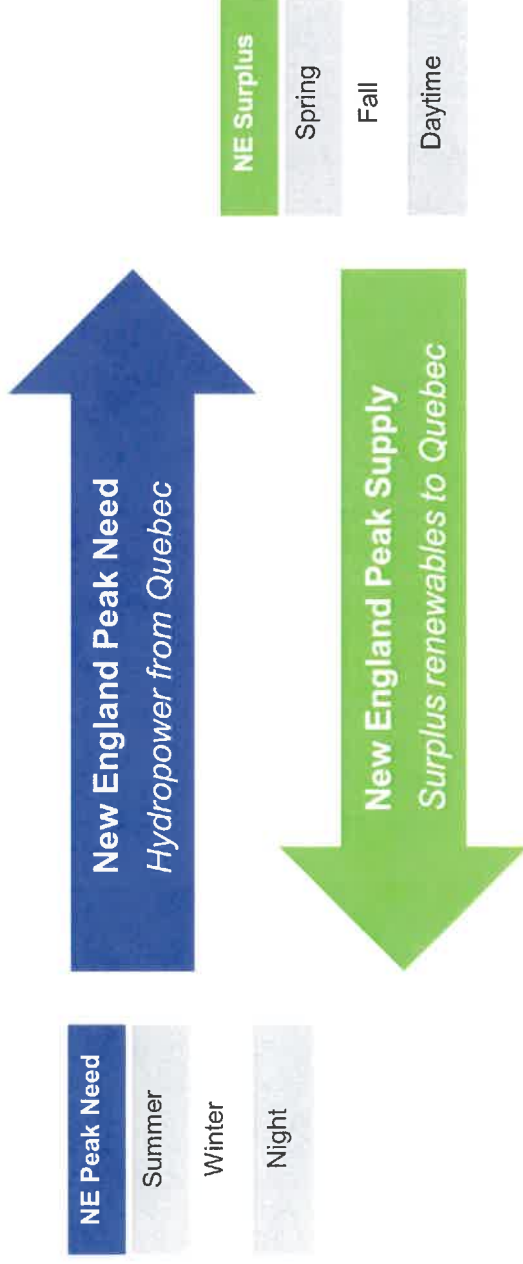

## Meeting the challenge



### *Is there another path forward?*

- Quebec has large amounts of clean hydro power that can serve as backup power in place of natural gas fired power when wind and solar output is low
- In fact, Quebec already sends large volumes of power to the region to serve the energy needs of New England homes and businesses
- The lines that Quebec currently uses to send power to New England experience very high use
- This means more lines are needed to Quebec to deliver the additional hydro power that New England needs as a clean alternative for power to back up wind and solar

## **DOE Transmission Facilitation Program**

- In late April, Twin States was invited by the Department of Energy to participate in Phase 2 of the Transmission Facilitation Program's (TFP) RFP process for capacity contracts, a recognition that they believe Twin States is a viable, buildable project that is potentially eligible for federal assistance.
- Twin States' Phase 2 RFP Response will be submitted on July 5th, with DOE deliberations throughout the summer.

## Twin States Clean Energy Link – A Ready Path to a Clean Energy Future

### ***What is Twin States and how can it help?***

- Twin States is a new transmission line from and to Quebec aimed at providing power to back up wind and solar in New England in place of fossil fuel generation
- Twin States would be constructed within existing rights of way through VT and NH, either underground (VT and NH) or as an upgrade to existing overhead lines (NH)

### ***How is Twin States different than the other proposed lines to Quebec that were strongly opposed?***

- Twin States enjoys strong support in New Hampshire, where projects have faced opposition in the past, because it requires almost no new rights of way and very little tree clearing
- Twin States will be built under state roads or as an upgrade to existing overhead lines, resulting in minimal visual impact for neighbors and visitors
- Twin States will be developed by National Grid, a company that makes communicating and partnering with host communities its top priority

## International Border Crossing, VT & Northern NH

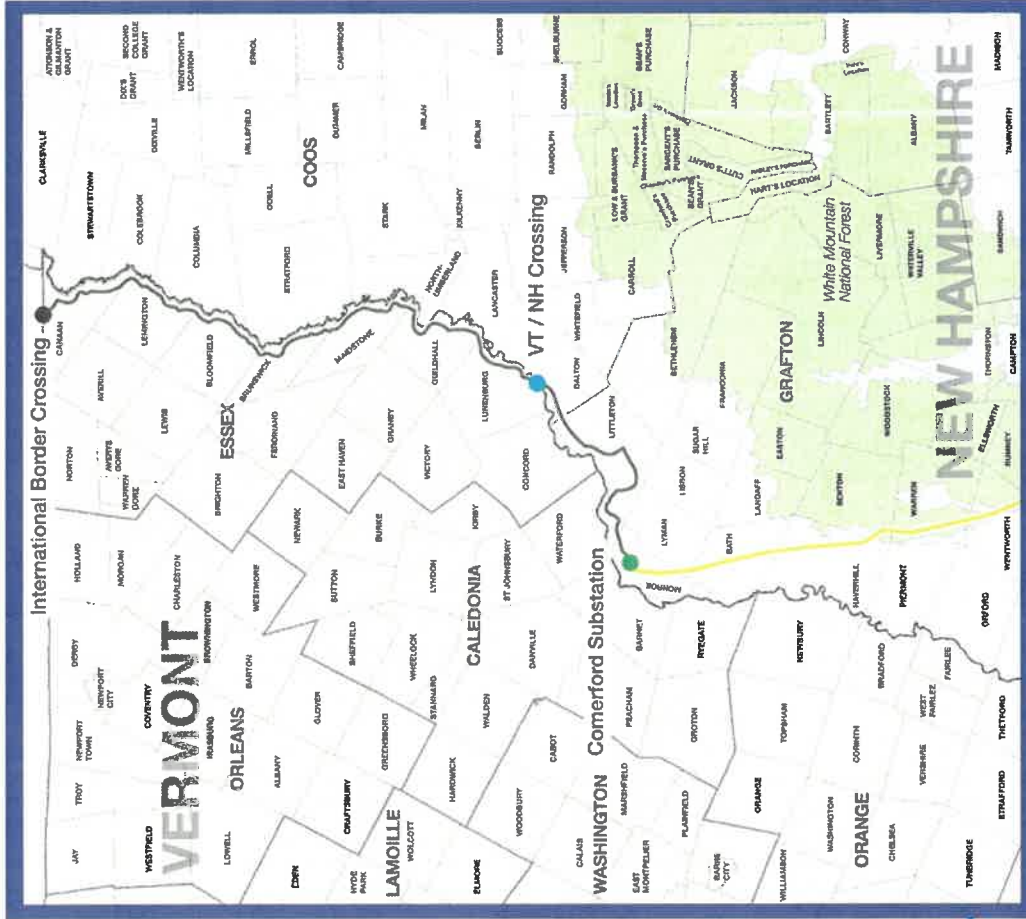

## New Hampshire Route

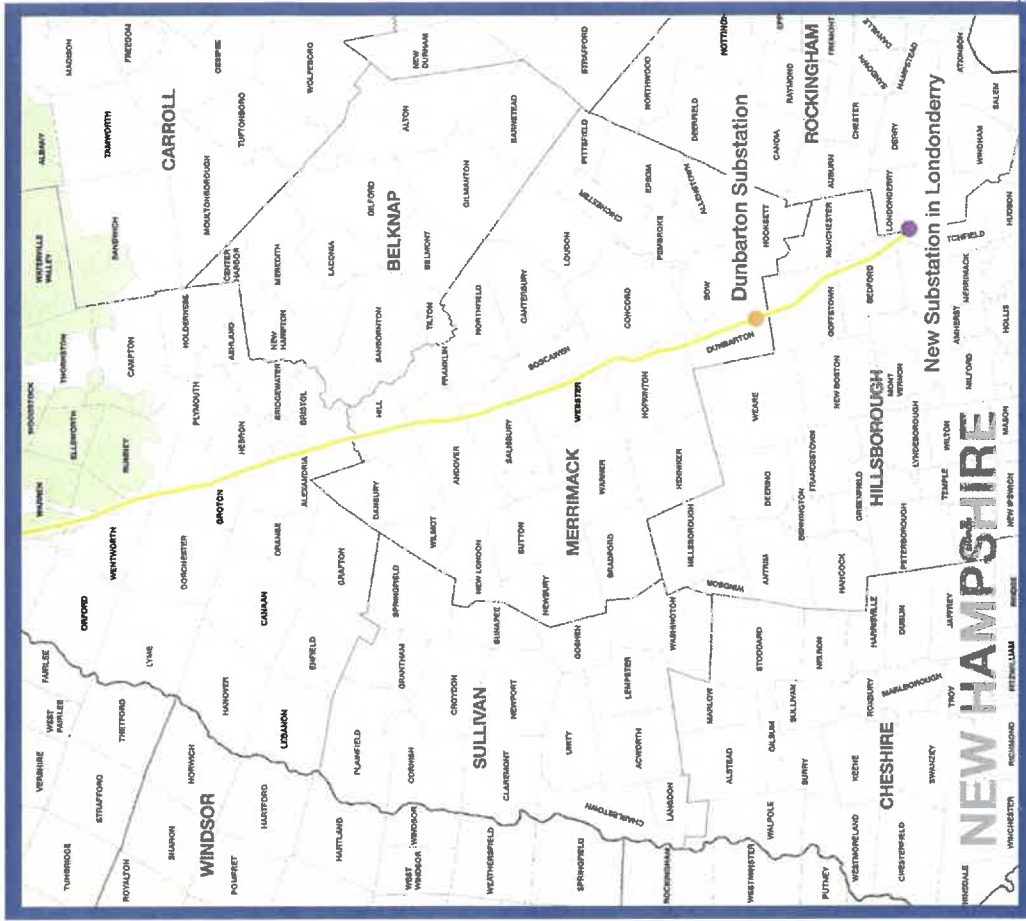



## Benefits for Host Communities & States

- **Host Community Benefits:** Twin States will provide host communities with hundreds of millions in property taxes revenue and other benefits packages towards community-identified needs. We would like for this to be the first of many conversations about how these programs can benefit Merrimack.
- **Regional Economic Development:** Twin States will pursue partnership with regional economic development agencies to help meet community needs and reinvestment opportunities
- **Job Creation:** Twin States has partnered with IBEW and local unions here in New Hampshire to ensure thousands of good paying jobs during construction and operations
- **Lower Energy Costs:** Twin States will lower energy costs for New Hampshire residents and businesses
- **Local Renewables:** Twin States will explore ways to enable new renewable power in NH's North Country
- **Stakeholder Collaboration:** Twin States will partner with entities to ensure economic benefits, understand local environment needs, and stakeholder alignment
  - Open discussions with local leaders and town managers to understand needs.
  - Ongoing communication with federal delegation and state elected officials.

## Benefits for all of New England

- **Lower Energy Costs:** Twin States will deliver billions of dollars of savings for customers across New England over the first 12 years alone
- **Drive New England's Clean Energy Economy:** As a bi-directional line, Twin States will provide the opportunity for clean energy generators across New England to export their surplus energy when it's not needed here, providing critical new markets, particularly for offshore wind projects in the region.
- **Reinvestment in EJ Communities:** Twin States has partnered with Citizens Energy, a Boston-based nonprofit, that will reinvest its profits of over \$100 million back to low-income families across the region. We are exploring opportunities to support workforce development, weatherization, and other community priorities.
- **Cleaner Environment:** Twin States will reduce GHG emissions from New England power producers by up to 4 million metric tons per year

## **Twin States in Merrimack**

- Estimated Annual Property Tax Increase After Construction: Estimated at \$25,000 per year based on current project design, timeline, and cost.
- 100% Within Existing Right-of-Way
- Total Mileage: 0.89 miles

# Twin States in Merrimack



# Twin States in Merrimack (Minimal Change / No Expansion)

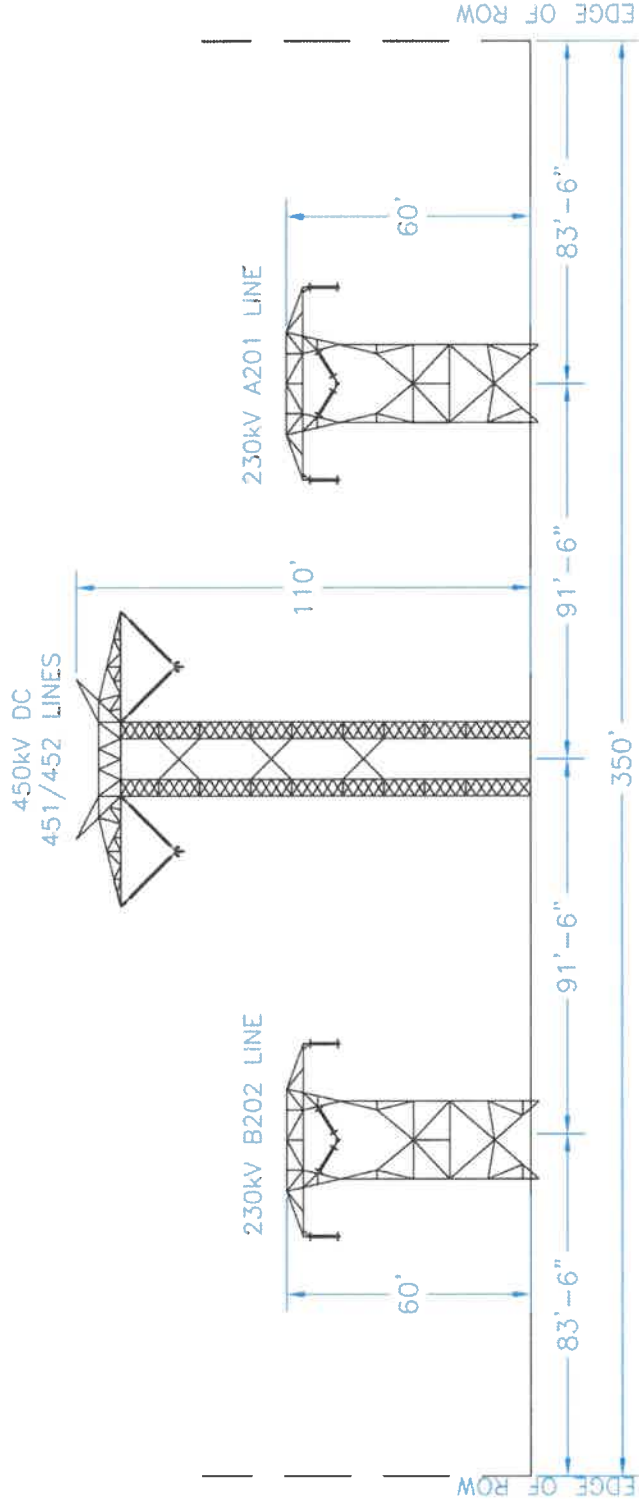

FIFTEEN MILE FALLS ROW  
 350' WIDE EASEMENT -- NEW ENGLAND POWER  
 COMERFORD SUBSTATION TO MILE 105.7  
 FACING TEWKSBURY  
 EXISTING CONFIGURATION

## Our Community Commitment

Twin States Clean Energy Link is committed to working together with host communities, residents, businesses, landowners, elected officials, and community groups throughout the application, proposal, siting, and construction processes.

We know from our past work that burying lines and using existing transmission corridors are important ways to minimize visual impacts.

We also understand that communities deserve comprehensive conversations and two-way communication about our work. Through local presentations, town-based community meetings, one-on-one discussions, mailings, a comprehensive website, toll-free hotline number, and other methods we will provide timely, comprehensive information to individuals and groups interested in the project. Above all, the Twin States team is committed to ongoing, open conversations about the project every step of the way.



PROJECT NEED AND OVERVIEW

COMMUNITY BENEFITS

PARTNERS

CONTACT

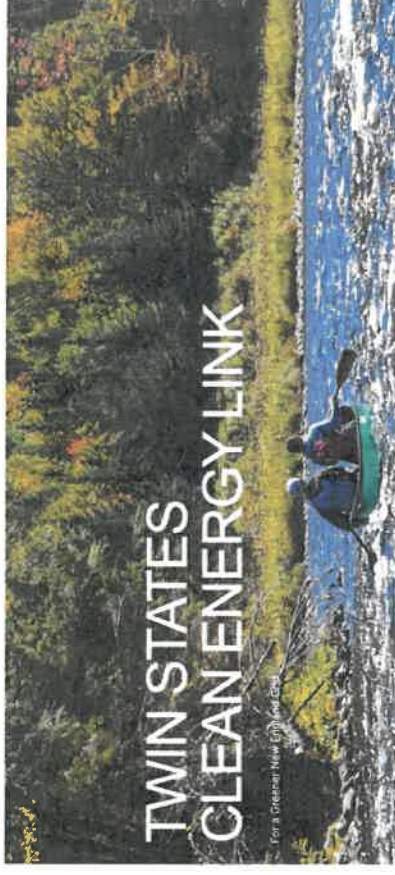

### **Contact us:**

[www.twinstatescleanenergylink.com](http://www.twinstatescleanenergylink.com)

[outreach@twinstatescleanenergylink.com](mailto:outreach@twinstatescleanenergylink.com)

1-800-886-8239

